

DIM.	TOL.
5mm DOWN	±0.2
5~20mm	±0.3
20~40mm	±0.4
40~60mm	±0.5
60 100mm	±0.8
100mm UP	±1.0

REVISIONS			
REV	DESCRIPTION	DATE	BY

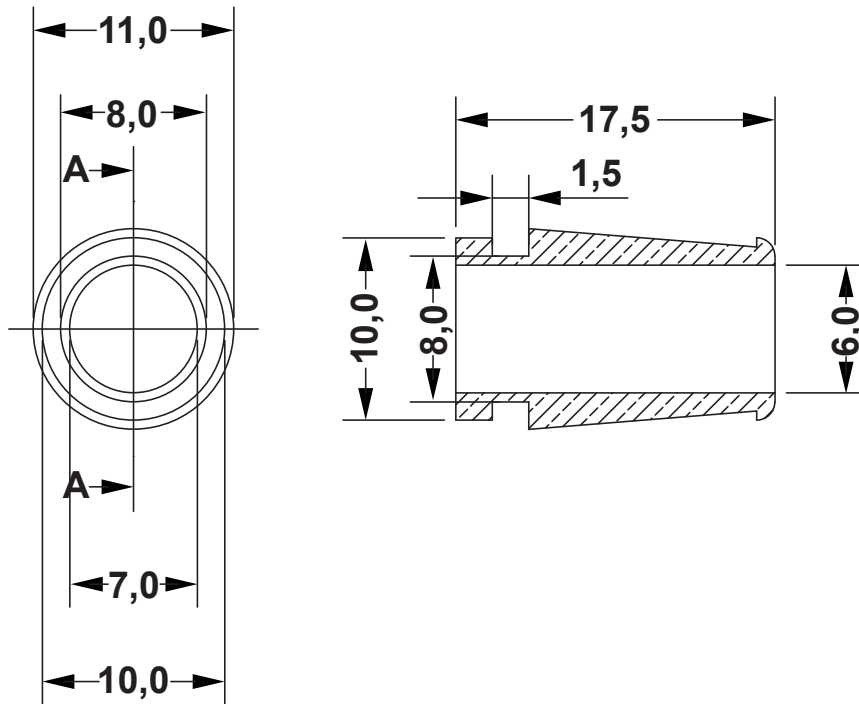

TITLE SOFT SPECIAL CABLE GROMMETS

MATERIAL PVC HB (UL94)

DATE 30/08/2017

COLOR BLACK

DRAWN R.F.

PART NUMBER 3460CA01

DRAWING NUMBER 17.08.30.3460.0.E

CHECK

SIZE A4 SCALE NTS

UNIT mm REV A

UNLESS OTHERWISE SPECIFIED TOLERANCE SEE ABOVE

APPROVED