

DIM.	TOL.
5mm DOWN	±0.2
5~20mm	±0.3
20~40mm	±0.4
40~60mm	±0.5
60~100mm	±0.8
100mm UP	±1.0

REVISIONS			
REV	DESCRIPTION	DATE	BY

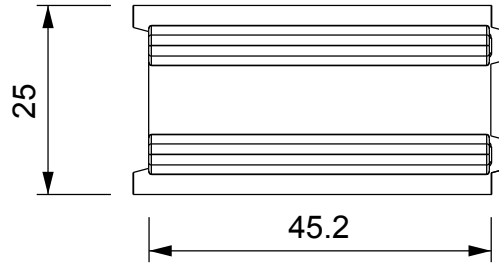
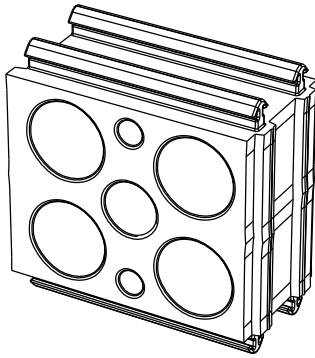
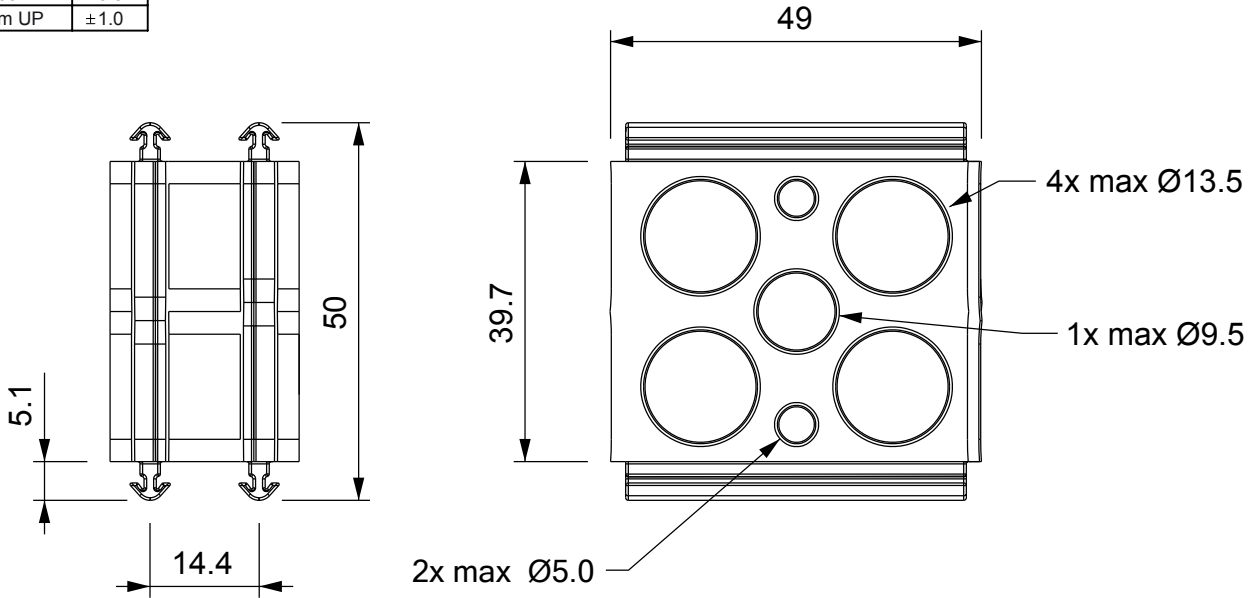

P/N	COLOR
18382PS01	BLACK
18382PS11	GREY

	IP66	NEMA 12, 4X	UL TYPE 12, 4X		

Flammability: UL94-V0, self-extinguishing
 Temperature: -40°C ... +110°C
 Properties: halogen-free, silicone-free

		TITLE SPG GROMMETS		
		MATERIAL TPE V0(UL94)	DATE 8/06/2023	
PART NUMBER SEE ABOVE		DRAWING NUMBER 23/06/08.18382.X.E	COLOR SEE ABOVE	CHECK
SIZE A4	SCALE NTS	UNIT mm.	REV A	UNLESS OTHERWISE SPECIFIED TOLERANCE SEE ABOVE
				APPROVED