

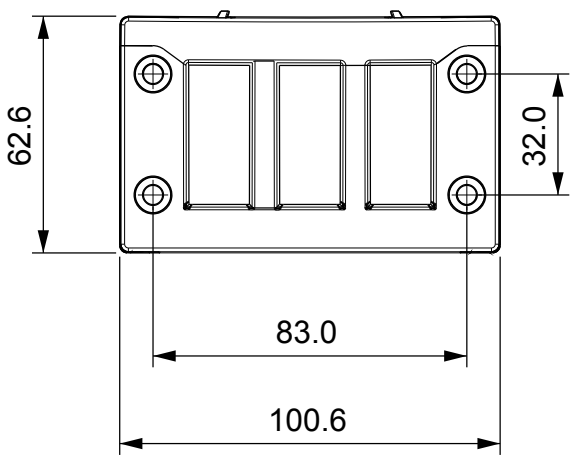

DIM.	TOL.
5mm DOWN	±0.2
5~20mm	±0.3
20~40mm	±0.4
40~60mm	±0.5
60~100mm	±0.8
100mm UP	±1.0

REVISIONS			
REV	DESCRIPTION	DATE	BY

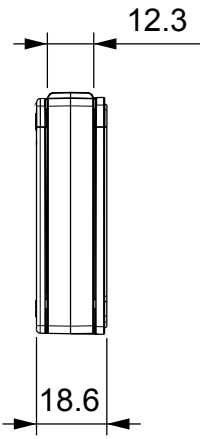
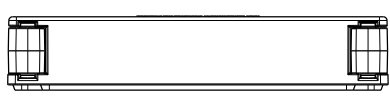
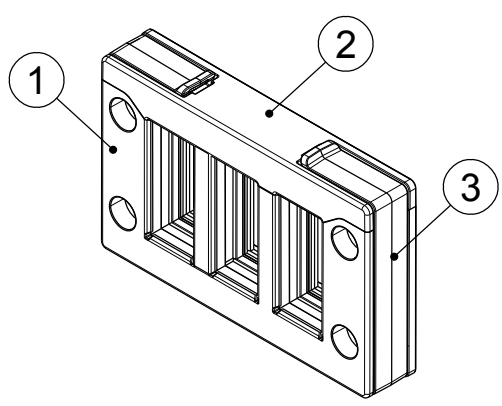
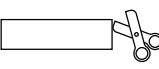

Temperature: -40°C ... +130°C
 Properties: halogen-free, silicone-free

Id	Description	Material	Q.	Recommended cut-out: 63 x 63 mm 	UL US	IP54	NEMA 12	HL3 EN 45545-2	APPROVED MARKING TYPE
1	Body	PP+GF	1						
2	Cap	PP+GF	1						
3	Clip	PP+GF	2						
4	Gasket (not visible)	NBR	1	ECOLAB	UL94-V0	UV ISO 4892 2A	RoHS COMPLIANT	IK10	

				TITLE SPLITTABLE FRAMES			
				MATERIAL SEE TABLE		DATE 28/02/2022	
PART NUMBER 15966FG01		DRAWING NUMBER 22.02.28.15966.0.E		UL94-V0		DRAWN A.C.	
SIZE A4		SCALE 1:2		COLOR BLACK		CHECK	
UNIT mm.		REV A		UNLESS OTHERWISE SPECIFIED TOLERANCE SEE ABOVE		APPROVED	