

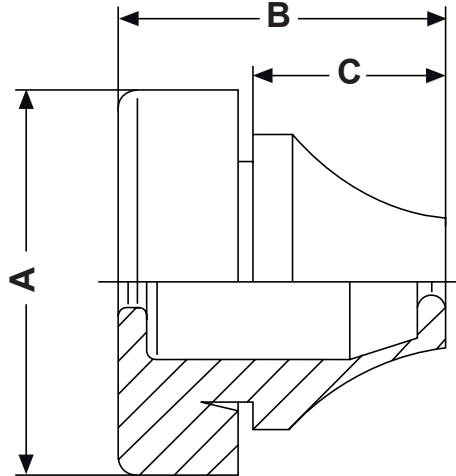

DIM.	TOL.
5mm DOWN	±0.2
5~20mm	±0.3
20~40mm	±0.4
40~60mm	±0.5
60~100mm	±0.8
100mm UP	±1.0

REVISIONS			
REV	DESCRIPTION	DATE	BY



P/N	SIZE	CABLE Ø	HOLE	THICKNESS	A	B	C
9030GS117035	M16	5,0 - 9,0	16,5	1,0 - 4,0	21,0	18,0	11,0
9031GS117035	M20	8,0 - 12,0	20,5	1,0 - 4,0	25,5	20,0	13,4
9022GS017035	M25	11,0 - 16,0	25,5	1,0 - 4,0	30,5	21,6	15,3

NOTE: Protection grade IP67 according to EN 60529 SEMKO conformity

				TITLE METRIC SNAP-FIT PROTECTION GROMMET IP67			
				MATERIAL EPDM		DATE 14/07/2022	
PART NUMBER SEE TABLE		DRAWING NUMBER 22.07.14.90XX.0.E		COLOR RAL 7035		CHECK	
SIZE A4	SCALE NTS	UNIT mm.	REV A	UNLESS OTHERWISE SPECIFIED TOLERANCE SEE ABOVE		APPROVED	