

DIM.	TOL
L ≤ 10	±0.2
10 < L ≤ 30	±0.3
30 < L ≤ 50	±0.5
50 < L ≤ 100	±0.7
100 < L ≤ 250	±1.2
ABOVE 250	±1.5

REVISIONS			
REV	DESCRIPTION	DATE	BY

THREAD DEEP	
A	F
5,0	8,0
6,0	10,0
7,0	12,0
10,0	15,0
10,0	20,0

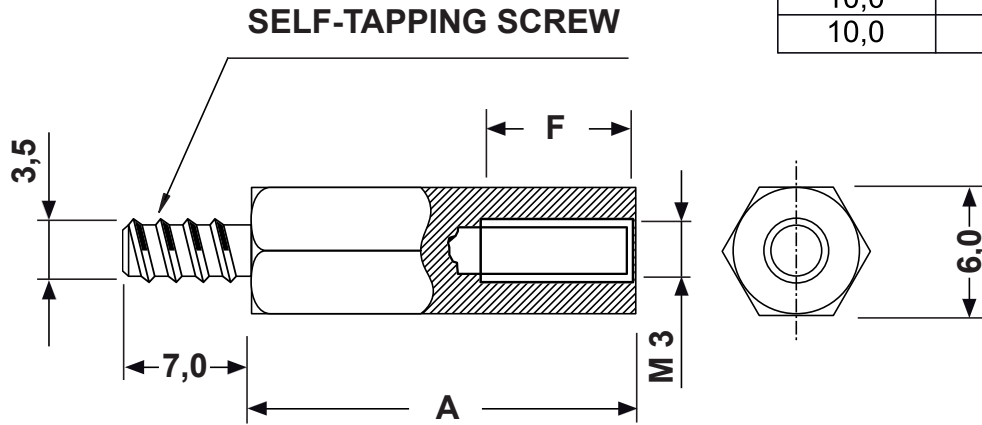

P/N	A
5945MA9208.0	08.0
5945MA9210.0	10.0
5945MA9212.0	12.0
5945MA9215.0	15.0
5945MA9220.0	20.0



fastpoint		TITLE SELF-TAPPING SPACERS	
		MATERIAL NICKEL-PLATED BRASS	DATE 21/03/2022
PART NUMBER SEE TABLE		DRAWN A.C.	
		DRAWING NUMBER 22.03.21.5945.0.E	
SIZE A4	SCALE NTS	COLOR	CHECK
UNIT mm.	REV A	UNLESS OTHERWISE SPECIFIED TOLERANCE SEE ABOVE	APPROVED