

REVISIONS			
REV	DESCRIPTION	DATE	BY

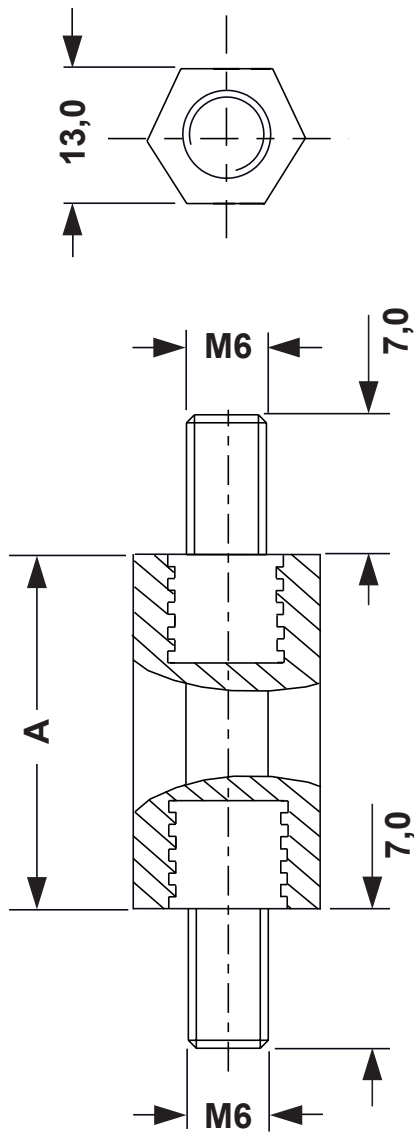

P/N	A
10491DA1115.0	15.0
10491DA1120.0	20.0
10491DA1125.0	25.0
10491DA1130.0	30.0
10491DA1140.0	40.0
10491DA1145.0	45.0
10491DA1150.0	50.0

DIELECTRIC STRENGTH 50KV



TITLE INSULATING POLYSTYROL & STEEL P.C.B SPACERS	
MATERIAL BODY POLYSTYROL	DATE 24/03/2022
MATERIAL THREAD INSERT ZINC PLATED	DRAWN A.C.
COLOR GREY	CHECK
UNLESS OTHERWISE SPECIFIED TOLERANCE SEE ABOVE	APPROVED

PART NUMBER SEE TABLE		DRAWING NUMBER 22.03.24.10491.0.E	
SIZE A4	SCALE NTS	UNIT mm.	REV A