

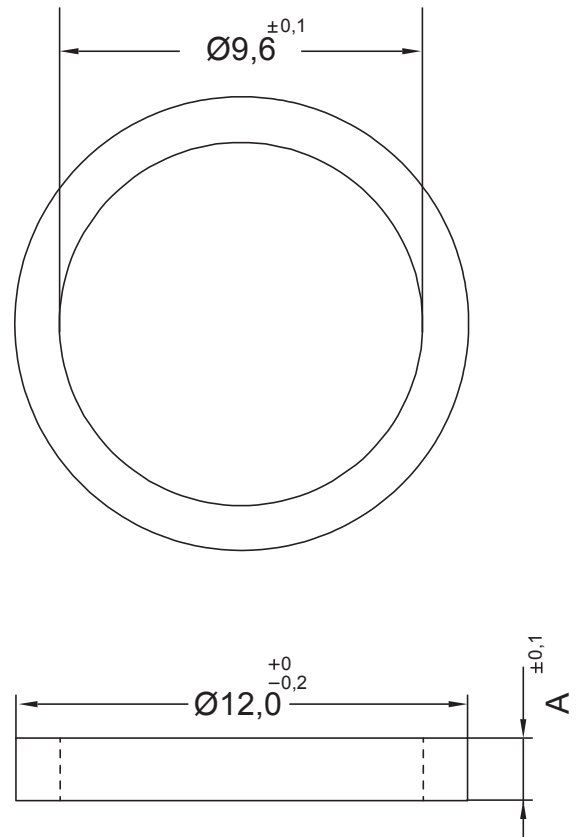

REVISIONS			
REV	DESCRIPTION	DATE	BY

P/N	A
10127BB0102.0	2.0
10127BB0103.0	3.0
10127BB0104.0	4.0
10127BB0105.0	5.0
10127BB0106.0	6.0
10127BB0107.0	7.0
10127BB0108.0	8.0
10127BB0109.0	9.0
10127BB0110.0	10.0
10127BB0111.0	11.0
10127BB0112.0	12.0
10127BB0113.0	13.0
10127BB0114.0	14.0
10127BB0115.0	15.0
10127BB0116.0	16.0
10127BB0117.0	17.0
10127BB0118.0	18.0
10127BB0119.0	19.0
10127BB0120.0	20.0
10127BB0121.0	21.0
10127BB0122.0	22.0
10127BB0123.0	23.0
10127BB0124.0	24.0
10127BB0125.0	25.0
10127BB0126.0	26.0
10127BB0127.0	27.0
10127BB0128.0	28.0
10127BB0129.0	29.0
10127BB0130.0	30.0
10127BB0131.0	31.0
10127BB0132.0	32.0
10127BB0133.0	33.0
10127BB0134.0	34.0
10127BB0135.0	35.0
10127BB0136.0	36.0
10127BB0137.0	37.0
10127BB0138.0	38.0
10127BB0139.0	39.0
10127BB0140.0	40.0

P/N	A
10127BB0141.0	41.0
10127BB0142.0	42.0
10127BB0143.0	43.0
10127BB0144.0	44.0
10127BB0145.0	45.0
10127BB0146.0	46.0
10127BB0147.0	47.0
10127BB0148.0	48.0
10127BB0149.0	49.0
10127BB0150.0	50.0



				TITLE ROUND P.C.B SPACERS	
				MATERIAL PA6 25% GF HB (UL94)	DATE 22/12/2021
PART NUMBER SEE TABLE				DRAWN A.C.	
				DRAWING NUMBER 21.12.22.10127.0.E	
SIZE A4	SCALE NTS	UNIT mm.	REV A	COLOR BLACK	CHECK
UNLESS OTHERWISE SPECIFIED TOLERANCE SEE ABOVE				APPROVED	