

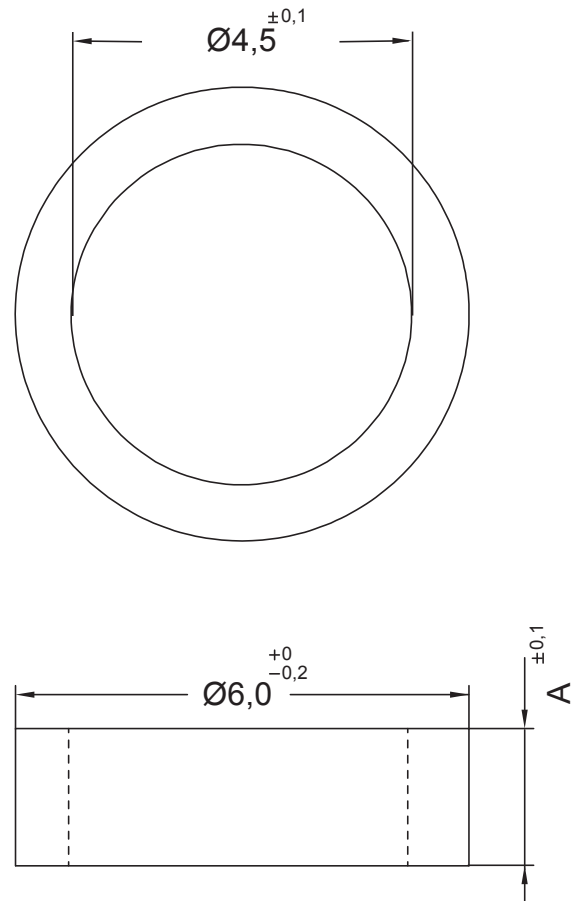

REVISIONS			
REV	DESCRIPTION	DATE	BY

P/N	A
10099BB0102.0	2.0
10099BB0103.0	3.0
10099BB0104.0	4.0
10099BB0105.0	5.0
10099BB0106.0	6.0
10099BB0107.0	7.0
10099BB0108.0	8.0
10099BB0109.0	9.0
10099BB0110.0	10.0
10099BB0111.0	11.0
10099BB0112.0	12.0
10099BB0113.0	13.0
10099BB0114.0	14.0
10099BB0115.0	15.0
10099BB0116.0	16.0
10099BB0117.0	17.0
10099BB0118.0	18.0
10099BB0119.0	19.0
10099BB0120.0	20.0
10099BB0121.0	21.0
10099BB0122.0	22.0
10099BB0123.0	23.0
10099BB0124.0	24.0
10099BB0125.0	25.0
10099BB0126.0	26.0
10099BB0127.0	27.0
10099BB0128.0	28.0
10099BB0129.0	29.0
10099BB0130.0	30.0
10099BB0131.0	31.0
10099BB0132.0	32.0
10099BB0133.0	33.0
10099BB0134.0	34.0
10099BB0135.0	35.0
10099BB0136.0	36.0
10099BB0137.0	37.0
10099BB0138.0	38.0
10099BB0139.0	39.0

P/N	A
10099BB0140.0	40.0
10099BB0141.0	41.0
10099BB0142.0	42.0
10099BB0143.0	43.0
10099BB0144.0	44.0
10099BB0145.0	45.0
10099BB0146.0	46.0
10099BB0147.0	47.0
10099BB0148.0	48.0
10099BB0149.0	49.0
10099BB0150.0	50.0
10099BB0151.0	51.0
10099BB0152.0	52.0
10099BB0153.0	53.0
10099BB0154.0	54.0



				TITLE ROUND P.C.B SPACERS	
				MATERIAL PA6 25% GF HB (UL94)	DATE 24/01/2022
PART NUMBER SEE TABLE				DRAWN A.C.	
				DRAWING NUMBER 22.01.24.10102.0.E	
SIZE A4	SCALE NTS	UNIT mm.	REV A	COLOR BLACK	APPROVED
UNLESS OTHERWISE SPECIFIED TOLERANCE SEE ABOVE					