

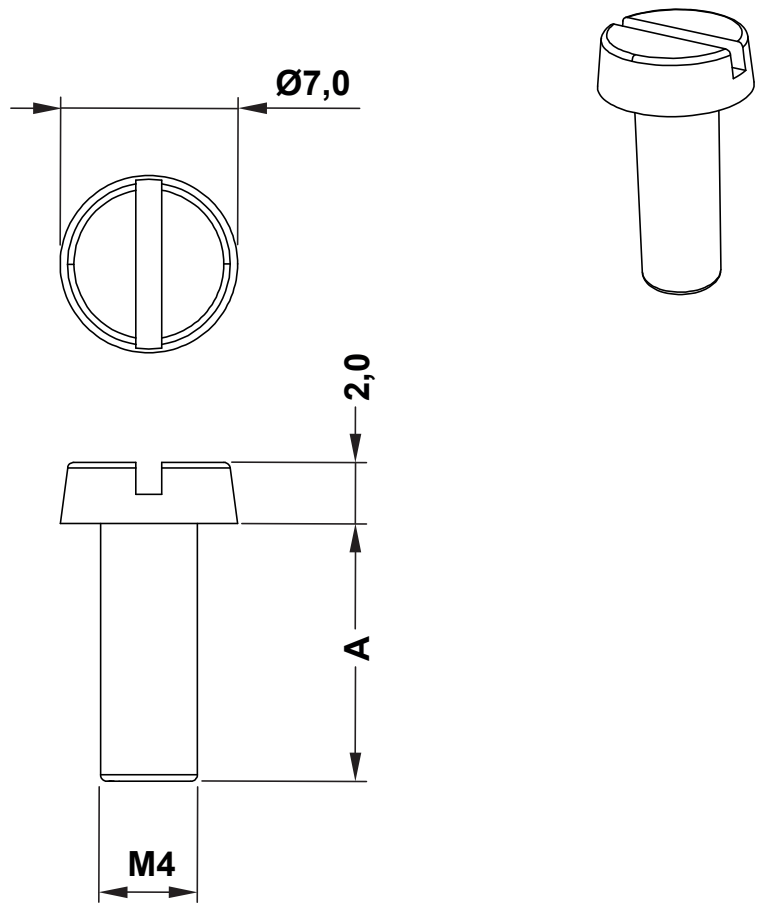

DIM.	TOL.
5mm DOWN	±0.2
5~20mm	±0.3
20~40mm	±0.4
40~60mm	±0.5
60~100mm	±0.8
100mm UP	±1.0

REVISIONS			
REV	DESCRIPTION	DATE	BY



P/N	A
10303AA0004.0	4.0
10303AA0005.0	5.0
10303AA0006.0	6.0
10303AA0008.0	8.0
10303AA0010.0	10.0
10303AA0012.0	12.0
10303AA0014.0	14.0

P/N	A
10303AA0016.0	16.0
10303AA0018.0	18.0
10303AA0020.0	20.0
10303AA0022.0	22.0
10303AA0025.0	25.0
10303AA0028.0	28.0
10303AA0030.0	30.0

		TITLE PAN HEAD SCREW WITH SLIT DIN EN ISO 1207 (EX DIN 84)	
		MATERIAL PA 6	DATE 04/03/2021
PART NUMBER SEE TABLE		DRAWN R.F.	
DRAWING NUMBER 21.03.04.10303.0.E		CHECK	
SIZE A4	SCALE NTS	COLOR NATURAL	APPROVED
UNIT mm.	REV A	UNLESS OTHERWISE SPECIFIED TOLERANCE SEE ABOVE	