

DIM.	TOL.
5mm DOWN	±0.2
5~20mm	±0.3
20~40mm	±0.4
40~60mm	±0.5
60~100mm	±0.8
100mm UP	±1.0

THREAD DEEP	
A	LENGTH
5,0	3,0
6,0	4,0
7,0	5,0
8,0	6,0
9,0	7,0
10,0	8,0
11,0	9,0
12,0 - 61,0	10,0

REVISIONS			
REV	DESCRIPTION	DATE	BY

P/N	A
5950AA0105.0	5.0
5950AA0106.0	6.0
5950AA0107.0	7.0
5950AA0108.0	8.0
5950AA0109.0	9.0
5950AA0110.0	10.0
5950AA0111.0	11.0
5950AA0112.0	12.0
5950AA0113.0	13.0
5950AA0114.0	14.0
5950AA0115.0	15.0
5950AA0116.0	16.0
5950AA0117.0	17.0
5950AA0118.0	18.0
5950AA0119.0	19.0
5950AA0120.0	20.0
5950AA0121.0	21.0
5950AA0122.0	22.0
5950AA0123.0	23.0
5950AA0124.0	24.0

P/N	A
5950AA0125.0	25.0
5950AA0126.0	26.0
5950AA0127.0	27.0
5950AA0128.0	28.0
5950AA0129.0	29.0
5950AA0130.0	30.0
5950AA0131.0	31.0
5950AA0132.0	32.0
5950AA0133.0	33.0
5950AA0134.0	34.0
5950AA0135.0	35.0
5950AA0136.0	36.0
5950AA0137.0	37.0
5950AA0138.0	38.0
5950AA0139.0	39.0
5950AA0140.0	40.0
5950AA0141.0	41.0
5950AA0142.0	42.0
5950AA0143.0	43.0
5950AA0144.0	44.0

P/N	A
5950AA0145.0	45.0
5950AA0146.0	46.0
5950AA0147.0	47.0
5950AA0148.0	48.0
5950AA0149.0	49.0
5950AA0150.0	50.0
5950AA0151.0	51.0
5950AA0152.0	52.0
5950AA0153.0	53.0
5950AA0154.0	54.0
5950AA0155.0	55.0
5950AA0156.0	56.0
5950AA0157.0	57.0
5950AA0158.0	58.0
5950AA0159.0	59.0
5950AA0160.0	60.0
5950AA0161.0	61.0

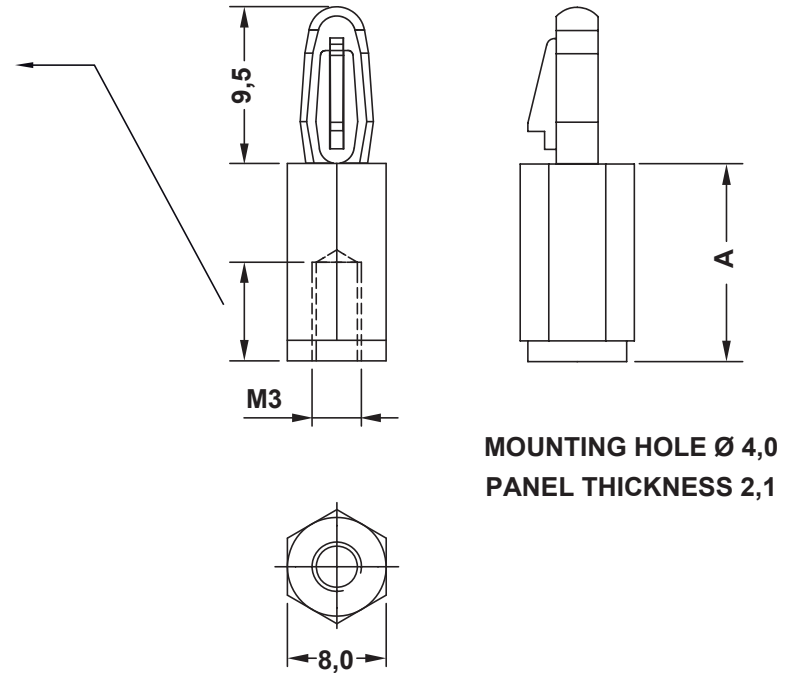

	DESCRIPTION	TITLE: METRIC THREADED SPACERS WITH SNAP-LOCK	DWG UNIT: MM
MATERIAL: PA66 V2(Ul 94)		Modelled in RHINO 4.0	FILE: DwN:02_04_21_5950.E.0
COLOUR: BLACK		TOLERANCES UNLESS NOTED	SHEET: 1 OF 1
		SEE ABOVE	DT:02/04/21
		SCALE: NTS	ChkD: Part Number: SEE TABLE
REV.	DATE		