

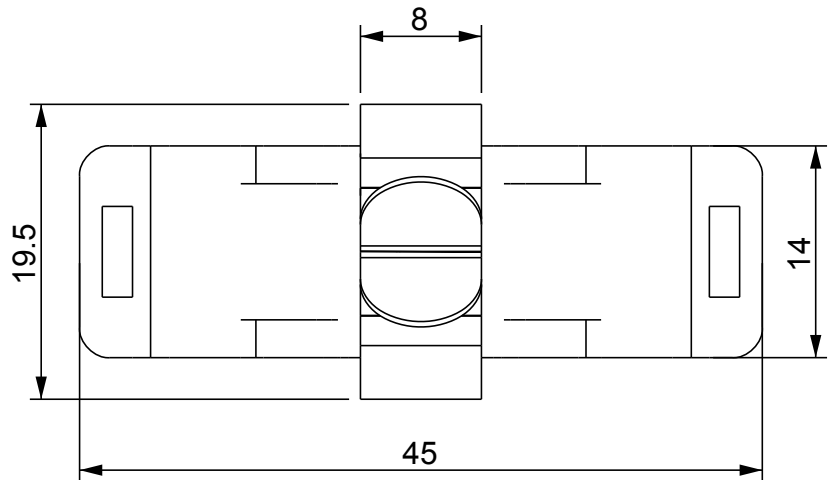

REVISIONS			
REV	DESCRIPTION	DATE	BY

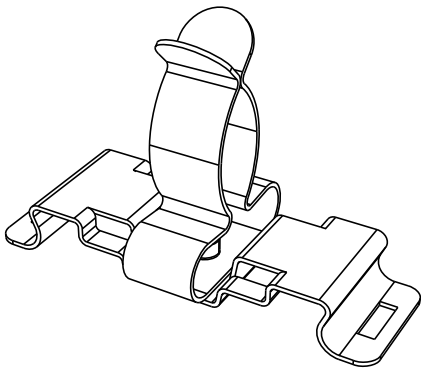
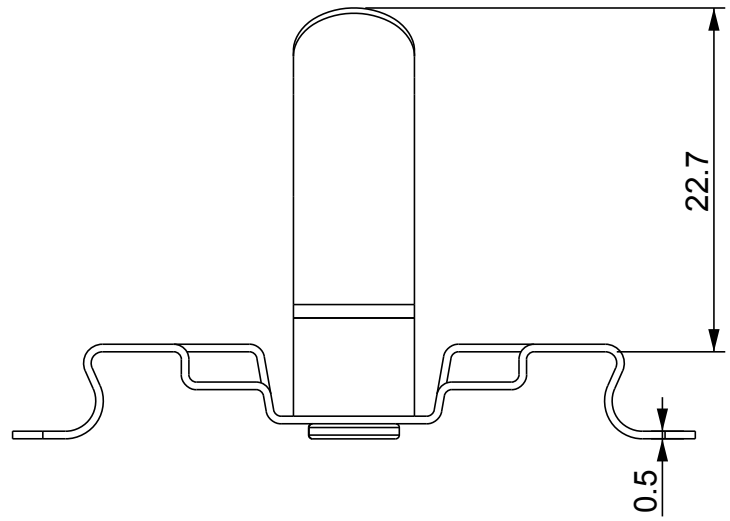
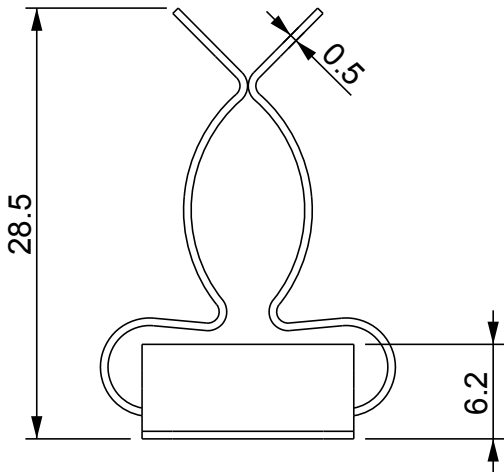

P/N FASTPOINT	P/N SUPPLIER
15249MC94	1734021090

				TITLE OMEGA RAILS WITH DOUBLE CABLE TIE SECURE	
				MATERIAL SPRING STEEL	DATE 12/05/2021
PART NUMBER SEE TABLE				DRAWING NUMBER 21.05.12.15249.0.E	
				FINISH ZINC PLATED	DRAWN R.F.
SIZE A4	SCALE 2:1	UNIT mm.	REV A	CHECK	
UNLESS OTHERWISE SPECIFIED TOLERANCE SEE ABOVE				APPROVED	