

DIM.	TOL.
5mm DOWN	±0.2
5~20mm	±0.3
20~40mm	±0.4
40~60mm	±0.5
60~100mm	±0.8
100mm UP	±1.0

REVISIONS			
REV	DESCRIPTION	DATE	BY

**MOUNTING HOLE Ø4,0
THICKNESS 2,1**

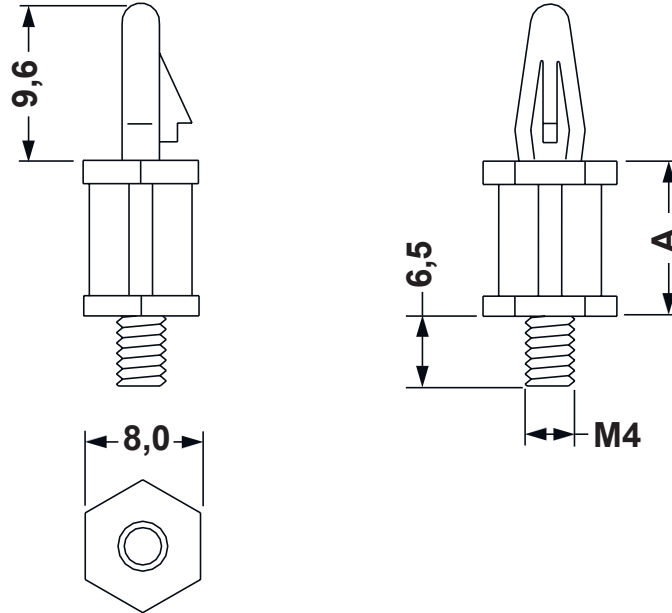

P/N	A
10062AA0103.0	3.0
10062AA0104.0	4.0
10062AA0105.0	5.0
10062AA0106.0	6.0
10062AA0107.0	7.0
10062AA0108.0	8.0
10062AA0109.0	9.0
10062AA0110.0	10.0
10062AA0111.0	11.0
10062AA0112.0	12.0
10062AA0113.0	13.0
10062AA0114.0	14.0
10062AA0115.0	15.0
10062AA0116.0	16.0
10062AA0117.0	17.0
10062AA0118.0	18.0
10062AA0119.0	19.0

P/N	A
10062AA0120.0	20.0
10062AA0121.0	21.0
10062AA0122.0	22.0
10062AA0123.0	23.0
10062AA0124.0	24.0
10062AA0125.0	25.0
10062AA0126.0	26.0
10062AA0127.0	27.0
10062AA0128.0	28.0
10062AA0129.0	29.0
10062AA0130.0	30.0
10062AA0131.0	31.0
10062AA0132.0	32.0
10062AA0133.0	33.0
10062AA0134.0	34.0
10062AA0135.0	35.0
10062AA0136.0	36.0

P/N	A
10062AA0137.0	37.0
10062AA0138.0	38.0
10062AA0139.0	39.0
10062AA0140.0	40.0
10062AA0141.0	41.0
10062AA0142.0	42.0
10062AA0143.0	43.0
10062AA0144.0	44.0
10062AA0145.0	45.0
10062AA0146.0	46.0
10062AA0147.0	47.0
10062AA0148.0	48.0
10062AA0149.0	49.0
10062AA0150.0	50.0
10062AA0151.0	51.0
10062AA0152.0	52.0
10062AA0153.0	53.0

P/N	A
10062AA0154.0	54.0
10062AA0155.0	55.0
10062AA0156.0	56.0
10062AA0157.0	57.0
10062AA0158.0	58.0
10062AA0159.0	59.0
10062AA0160.0	60.0
10062AA0161.0	61.0
10062AA0162.0	62.0
10062AA0163.0	63.0
10062AA0164.0	64.0
10062AA0165.0	65.0

				TITLE METRIC THREADED SPACERS WITH SNAP-LOCK	
				MATERIAL PA66 HB(UL94)	
PART NUMBER SEE TABLE				DRAWING NUMBER 21.03.23.10062.0.E	
DRAWING NUMBER 21.03.23.10062.0.E				DRAWN R.F.	
DRAWN R.F.				CHECK	
COLOR BLACK				CHECK	
UNLESS OTHERWISE SPECIFIED TOLERANCE SEE ABOVE				APPROVED	
SIZE A4	SCALE NTS	UNIT mm.	REV A		