

DIM.	TOL.
5mm DOWN	±0.2
5~20mm	±0.3
20~40mm	±0.4
40~60mm	±0.5
60~100mm	±0.8
100mm UP	±1.0

REVISIONS			
REV	DESCRIPTION	DATE	BY

**MOUNTING HOLE Ø4,0
THICKNESS 2,1**

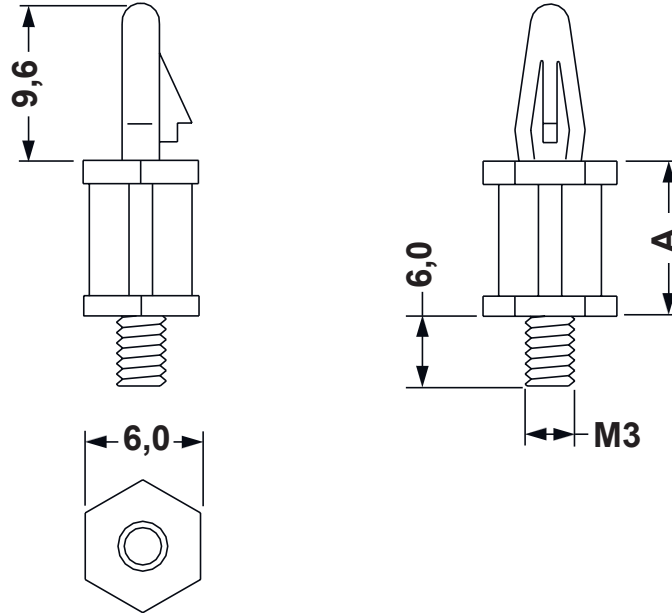

P/N	A
10056AA0103.0	3.0
10056AA0104.0	4.0
10056AA0105.0	5.0
10056AA0106.0	6.0
10056AA0107.0	7.0
10056AA0108.0	8.0
10056AA0109.0	9.0
10056AA0110.0	10.0
10056AA0111.0	11.0
10056AA0112.0	12.0
10056AA0113.0	13.0
10056AA0114.0	14.0
10056AA0115.0	15.0
10056AA0116.0	16.0
10056AA0117.0	17.0
10056AA0118.0	18.0
10056AA0119.0	19.0

P/N	A
10056AA0120.0	20.0
10056AA0121.0	21.0
10056AA0122.0	22.0
10056AA0123.0	23.0
10056AA0124.0	24.0
10056AA0125.0	25.0
10056AA0126.0	26.0
10056AA0127.0	27.0
10056AA0128.0	28.0
10056AA0129.0	29.0
10056AA0130.0	30.0
10056AA0131.0	31.0
10056AA0132.0	32.0
10056AA0133.0	33.0
10056AA0134.0	34.0
10056AA0135.0	35.0
10056AA0136.0	36.0

P/N	A
10056AA0137.0	37.0
10056AA0138.0	38.0
10056AA0139.0	39.0
10056AA0140.0	40.0
10056AA0141.0	41.0
10056AA0142.0	42.0
10056AA0143.0	43.0
10056AA0144.0	44.0
10056AA0145.0	45.0
10056AA0146.0	46.0
10056AA0147.0	47.0
10056AA0148.0	48.0
10056AA0149.0	49.0
10056AA0150.0	50.0
10056AA0151.0	51.0
10056AA0152.0	52.0
10056AA0153.0	53.0

P/N	A
10055AA0154.0	54.0
10056AA0155.0	55.0
10056AA0156.0	56.0
10056AA0157.0	57.0
10056AA0158.0	58.0
10056AA0159.0	59.0
10056AA0160.0	60.0
10056AA0161.0	61.0
10056AA0162.0	62.0
10056AA0163.0	63.0
10056AA0164.0	64.0
10056AA0165.0	65.0

		TITLE METRIC THREADED SPACERS WITH SNAP-LOCK	
		MATERIAL PA66 HB(UL94)	DATE 23/03/2021
PART NUMBER SEE TABLE		DRAWING NUMBER 21.03.23.10056.0.E	
DRAWN R.F.		COLOR BLACK	CHECK
SIZE A4	SCALE NTS	UNIT mm.	REV A
UNLESS OTHERWISE SPECIFIED TOLERANCE SEE ABOVE		APPROVED	