

DIM.	TOL.
5mm DOWN	±0.2
5~20mm	±0.3
20~40mm	±0.4
40~60mm	±0.5
60~100mm	±0.8
100mm UP	±1.0

REVISIONS			
REV	DESCRIPTION	DATE	BY

**MOUNTING HOLE Ø4,0
PANEL THICKNESS 1,5**

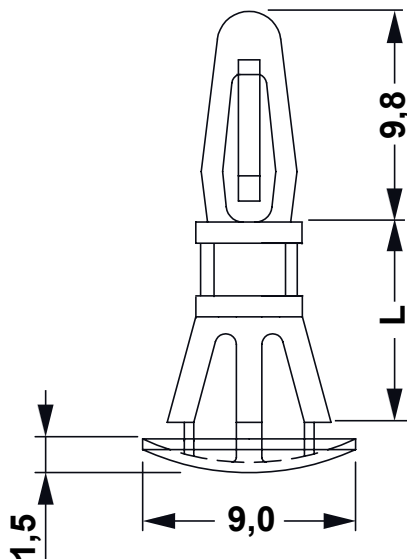

**MOUNTING HOLE Ø5,0
PANEL THICKNESS 1,0**

P/N	L
10008AA0104.0	4.0
10008AA0105.0	5.0
10008AA0106.0	6.0
10008AA0107.0	7.0
10008AA0108.0	8.0
10008AA0109.0	9.0
10008AA0110.0	10.0
10008AA0111.0	11.0
10008AA0112.0	12.0
10008AA0113.0	13.0
10008AA0114.0	14.0
10008AA0115.0	15.0

P/N	L
10008AA0116.0	16.0
10008AA0117.0	17.0
10008AA0118.0	18.0
10008AA0119.0	19.0
10008AA0120.0	20.0
10008AA0121.0	21.0
10008AA0122.0	22.0
10008AA0123.0	23.0
10008AA0124.0	24.0
10008AA0125.0	25.0
10008AA0126.0	26.0
10008AA0127.0	27.0

P/N	L
10008AA0128.0	28.0
10008AA0129.0	29.0
10008AA0130.0	30.0
10008AA0131.0	31.0
10008AA0132.0	32.0
10008AA0133.0	33.0
10008AA0134.0	34.0
10008AA0135.0	35.0
10008AA0136.0	36.0

				TITLE REVERSE LOCKING P.C.B SPACER	
				MATERIAL PA 66 HB(UL94)	
PART NUMBER SEE TABLE		DRAWING NUMBER 19.12.04.10008.0.E		DRAWN R.F.	
SIZE A4		SCALE NTS		CHECK	
UNIT mm.		REV A		APPROVED	
COLOR BLACK				UNLESS OTHERWISE SPECIFIED TOLERANCE SEE ABOVE	