

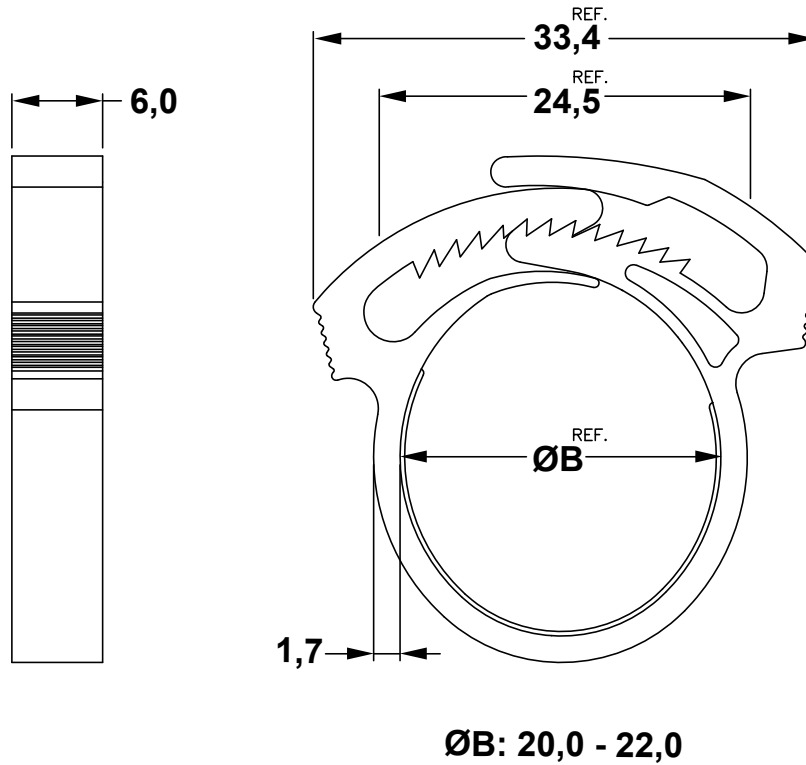

DIM.	TOL
L ≤ 10	±0.2
10 < L ≤ 30	±0.3
30 < L ≤ 50	±0.5
50 < L ≤ 100	±0.7
100 < L ≤ 250	±1.2
ABOVE 250	±1.5

REVISIONS			
REV	DESCRIPTION	DATE	BY



				TITLE CLIP HOSE CLAMP	
				MATERIAL POM HB(UL94)	24/04/2020
PART NUMBER 6872GA00				FINISH	DRAWN R.F.
DRAWING NUMBER 20.04.24.6872.E.0				COLOR NATURAL	CHECK
SIZE A4	SCALE 2:1	UNIT mm	REV	UNLESS OTHERWISE SPECIFIED TOLERANCE SEE ABOVE	APPROVED