

DIM.	TOL.
5mm DOWN	±0.2
5~20mm	±0.3
20~40mm	±0.4
40~60mm	±0.5
60 100mm	±0.8
100mm UP	±1.0

REVISIONS			
REV	DESCRIPTION	DATE	BY

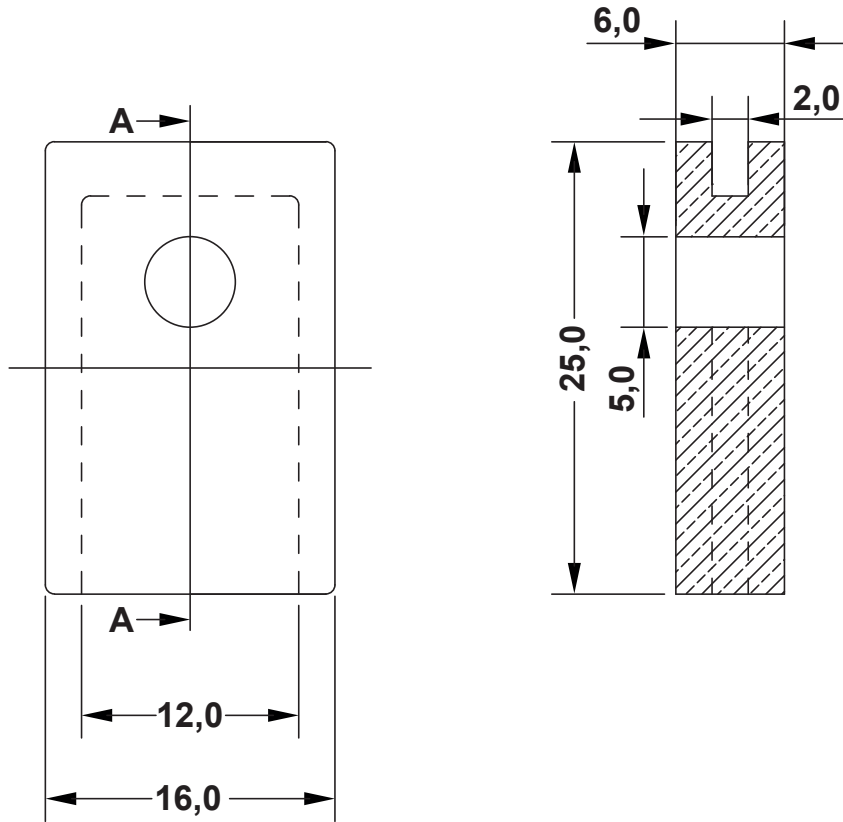

<b>fastpoint</b>		TITLE SOFT BORDER GROMMETS			
		MATERIAL PVC HB(UL94)	DATE 31/08/2017		
		COLOR BLACK	DRAWN R.F.		
PART NUMBER 4380CA01	DRAWING NUMBER 17.08.31.4380.0.E	CHECK			
SIZE A4	SCALE NTS	UNIT mm	REV A	UNLESS OTHERWISE SPECIFIED TOLERANCE SEE ABOVE	APPROVED