

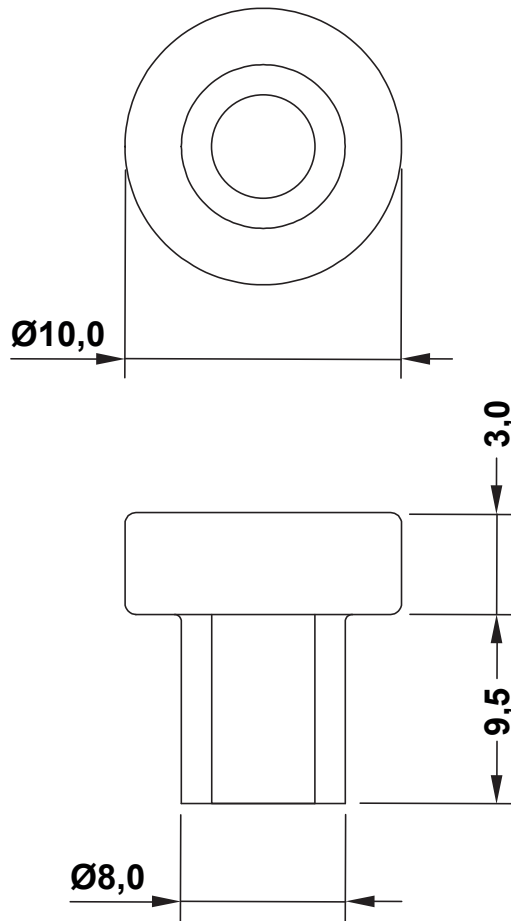

REVISIONS			
REV	DESCRIPTION	DATE	BY



				TITLE PCV FEET AND PUSH-IN BUMPER	
				MATERIAL PVC	
PART NUMBER 3658CA01				DRAWING NUMBER 21.02.22.3658.0.E	
COLOR BLACK				CHECK	
SIZE A4	SCALE NTS	UNIT mm.	REV A	UNLESS OTHERWISE SPECIFIED TOLERANCE SEE ABOVE	
				APPROVED	