

REVISIONS			
REV	DESCRIPTION	DATE	BY

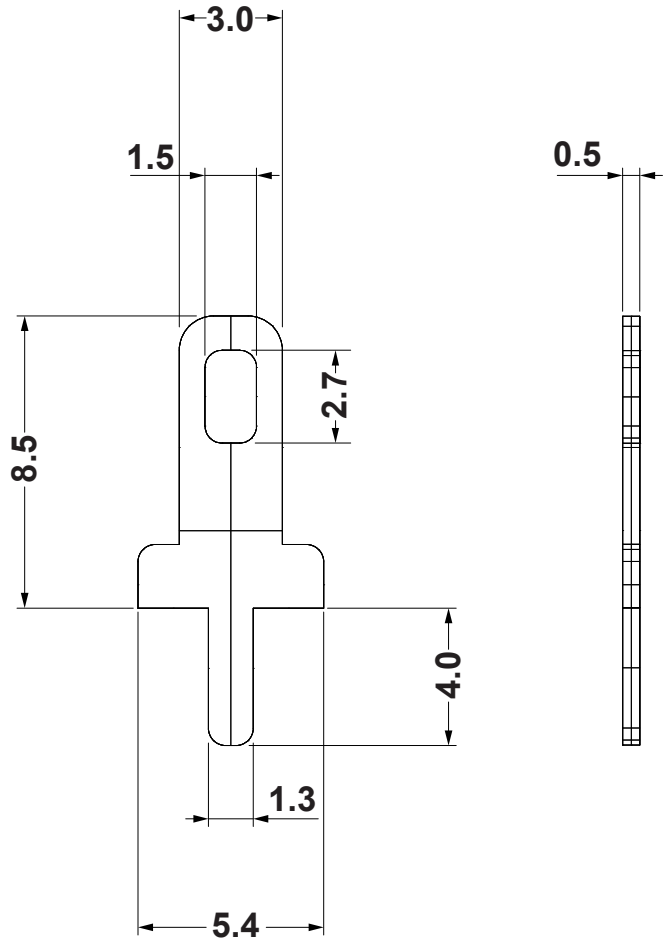
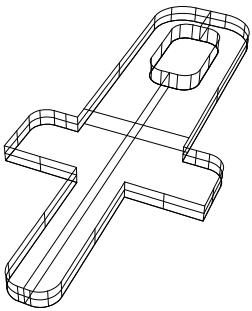

TITLE **TABS FOR P.B.C.**

MATERIAL **TIN-PLATED BRASS** DATE **21/01/2019**

COLOR DRAWN **R.F.**

UNLESS OTHERWISE SPECIFIED TOLERANCE CHECK APPROVED

PART NUMBER **1422MA91** DRAWING NUMBER **19.01.21.1422.0.E**

SIZE **A4** SCALE **NTS** UNIT **mm.** REV **A**