

DIM.	TOL.
5mm DOWN	±0.2
5~20mm	±0.3
20~40mm	±0.4
40~60mm	±0.5
60~100mm	±0.8
100mm UP	±1.0

REVISIONS			
REV	DESCRIPTION	DATE	BY

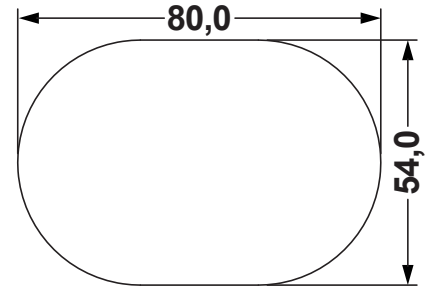

**MOUNTING HOLE**  
**PANEL THICKNESS: 1,2 - 3,0**

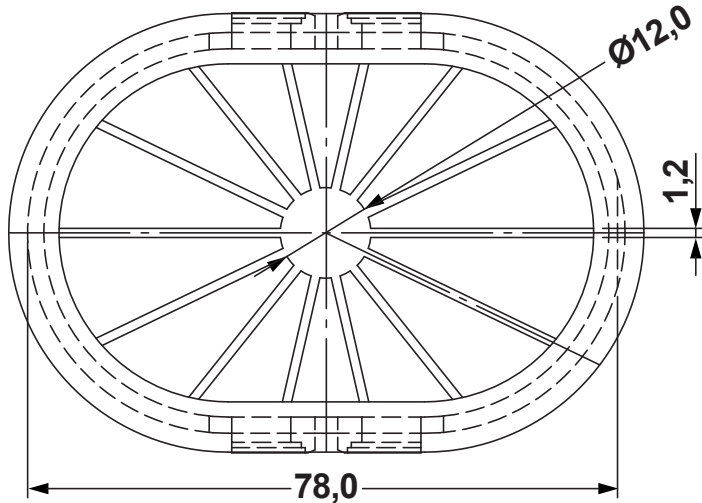
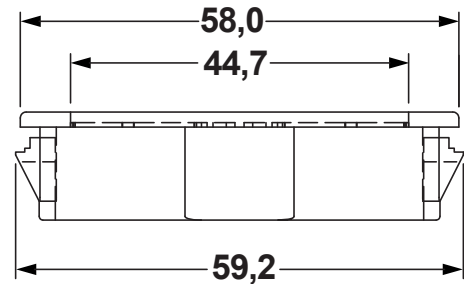
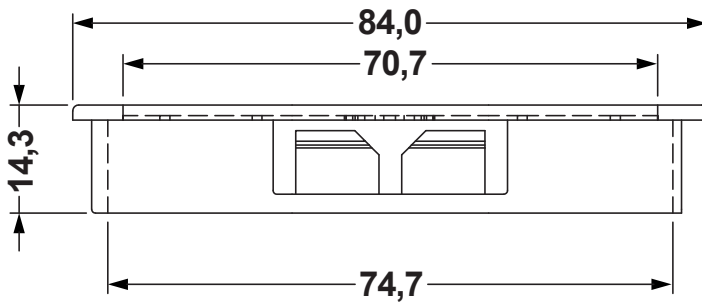

TITLE  
**RIGID SNAP CABLE BUSHINGS WITH MEMBRANE**

MATERIAL  
**NYLON 66 UL94V-2**

DATE  
**13/02/2017**

HARDNESS

DRAWN  
**R.F.**

PART NUMBER  
**8469AA01**

DRAWING NUMBER  
**17.02.13.8469.0.E**

COLOR  
**BLACK**

CHECK

SIZE  
**A4**

SCALE  
**1:1**

UNIT  
**mm**

REV  
**A**

UNLESS OTHERWISE SPECIFIED TOLERANCE  
**SEE ABOVE**

APPROVED