

Dimensions	Tolerance
5mm DOWN	±0.2
5~20mm	±0.3
20~40mm	±0.4
40~60mm	±0.5
60~100mm	±0.8
100mm UP	±1.0

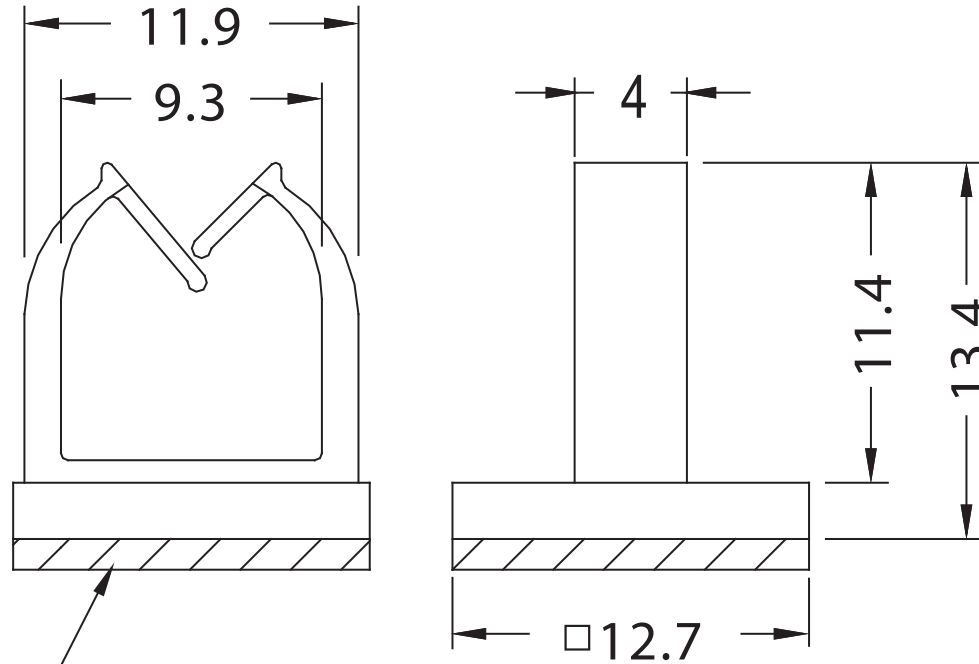

3M DOUBLE ADHESIVE TAPE
(THICKNESS 1.1mm)

REV.	DESCRIPTION	DATE	TITLE: SELF ADHESIVE WIRE CLIP	FILE: 09/12/14 SHEET: 1 OF 1	DwN: DT: 14.09.12.6273E.0	DWG UNIT: MM	ChkD: Part Number: 6273AA00AS
	MATERIAL: PA 66 (UL) 94 V-2 COLOUR: NATURAL		TOLLERANCES UNLESS NOTED .XX= +/-010 .XXX= +/-005 FRAC.=+/- 1/64 ANG.=+/-1°	SCALE: NTS			

