

DIM.	TOL
5mm DOWN	±0.2
5~20mm	±0.3
20~40mm	±0.4
40~60mm	±0.5
60~100mm	±0.8
100mm UP	±1.0

REVISIONS			
REV	DESCRIPTION	DATE	BY

PART NO.	A
6127AA00	4.8
6128AA00	6.4
6129AA00	9.5
6130AA00	12.7
6131AA00	15.9
6132AA00	19.1
6133AA00	22.2

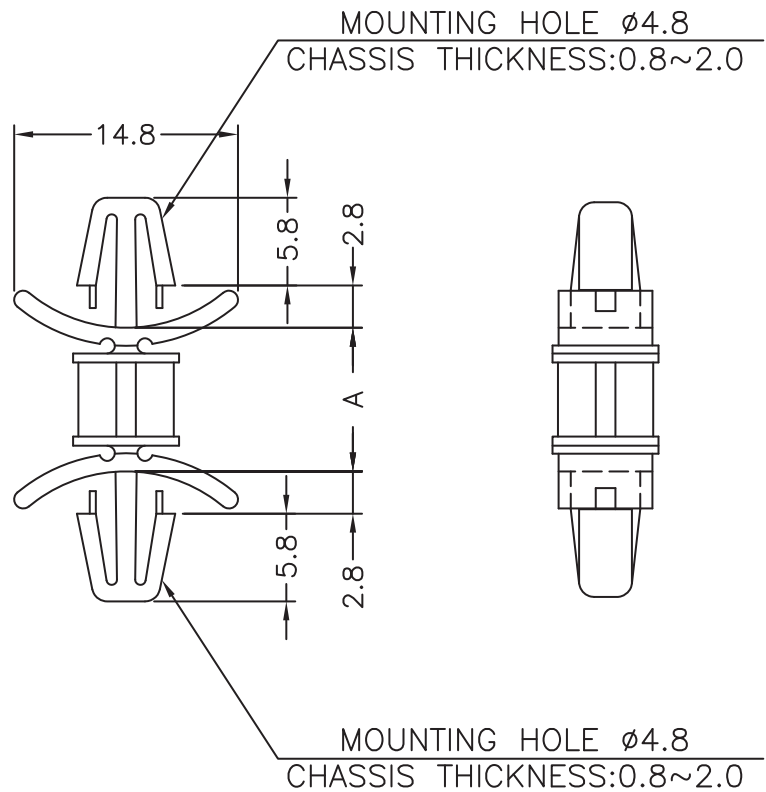

fastpoint		TITLE DUAL LOCKING P.C.B. SPACER	
		MATERIAL PA66 V2 UL94	DATE 17/05/2011
PART NUMBER SEE TABLE		DRAWN J.D.	
DRAWING NUMBER 11.05.17.6127.0.E		COLOR NATURAL	CHECK
SIZE A4	SCALE NTS	UNIT mm.	REV A
UNLESS OTHERWISE SPECIFIED TOLERANCE SEE ABOVE		APPROVED	