

DIM.	TOL.
5mm DOWN	±0.2
5~20mm	±0.3
20~40mm	±0.4
40~60mm	±0.5
60 100mm	±0.8
100mm UP	±1.0

REVISIONS			
REV	DESCRIPTION	DATE	BY

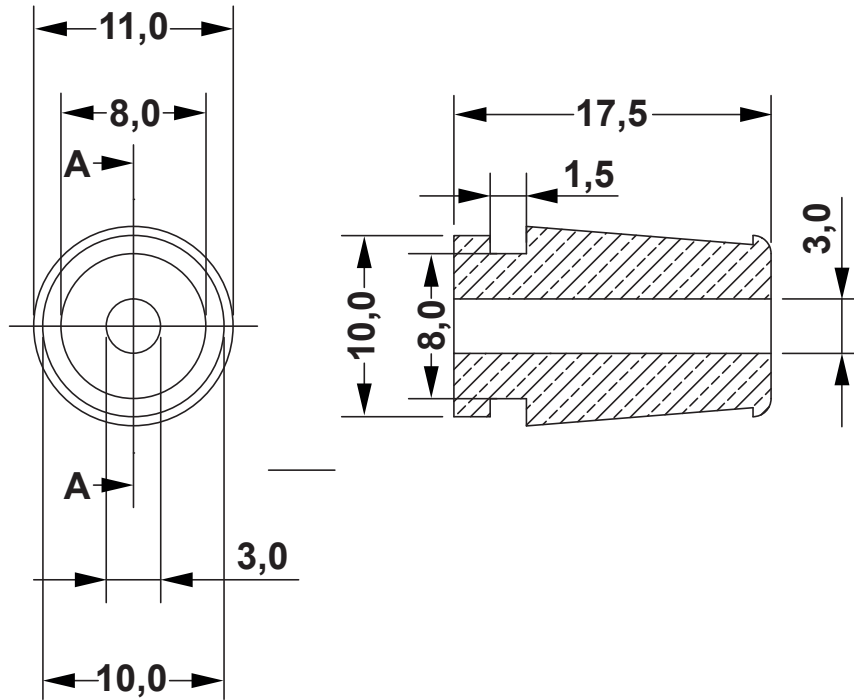

TITLE SOFT SPECIAL CABLE GROMMETS		MATERIAL PVC HB (UL94)		DATE 30/08/2017		
		COLOR BLACK		DRAWN R.F.		
		PART NUMBER 3457CA01		DRAWING NUMBER 17.08.30.3457.0.E		CHECK
SIZE A4	SCALE NTS	UNIT mm	REV A	UNLESS OTHERWISE SPECIFIED TOLERANCE SEE ABOVE		APPROVED