

DIM.	TOL.
5mm DOWN	±0.2
5~20mm	±0.3
20~40mm	±0.4
40~60mm	±0.5
60~100mm	±0.8
100mm UP	±1.0

REVISIONS			
REV	DESCRIPTION	DATE	BY

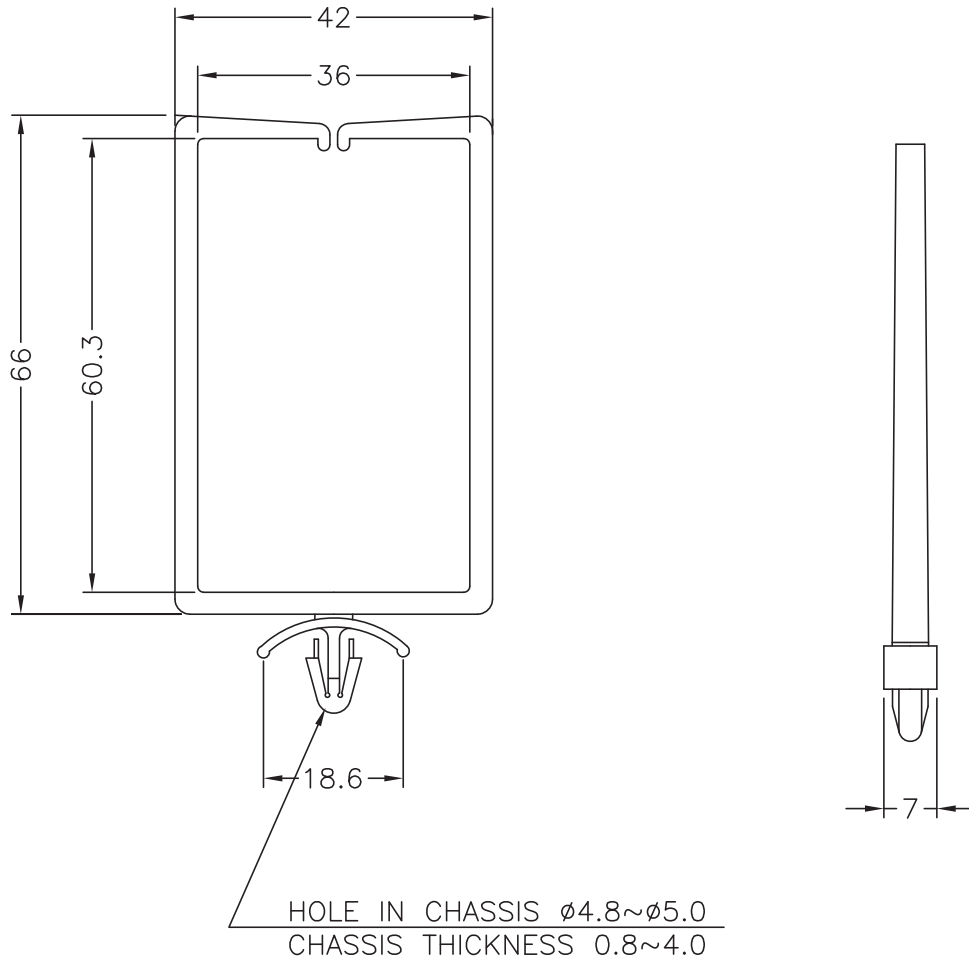

NOTE:

1. Shrinking is normal status.
2. All measurement does not include gate which raises under 0.3 mm.



				TITLE WIRE HOLDER			
				MATERIAL NYLON 66 UL94V-2		DATE 16/09/2015	
				DRAWN S.P.			
PART NUMBER 10972AA00		DRAWING NUMBER 16.09.15.10972.0.E		COLOR NATURAL		CHECK	
SIZE A4	SCALE 1:1	UNIT mm	REV A	UNLESS OTHERWISE SPECIFIED TOLERANCE SEE ABOVE		APPROVED	