

A - A

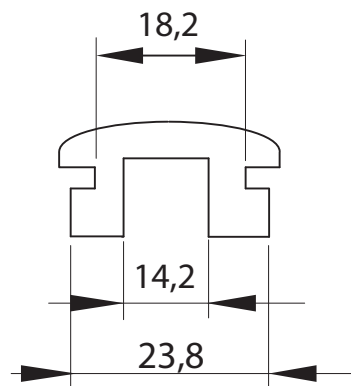

	DESCRIPTION		TITLE: <b>Verschlussstopfen / Hole Grommet</b>	DWG UNIT: MM
MATERIAL:	Chloroprene Rubber		Modelled in RHINO 4.0	FILE: DwN: 30.07.2015
Farbe:	schwarz / black		TOLLERANCES UNLESS NOTED	SHEET: 1 OF 1
Temperatur:	-45°C - +110°C		DIN ISO 3302-1	DT: Part Number: 10925CR01
REV.		DATE	SCALE: NTS	