

Dimensions	Tolerance
L≤10	±0.2
10<L≤30	±0.3
30<L≤50	±0.5
50<L≤100	±0.7
100<L≤250	±1.2
ABOVE 250	±1.5

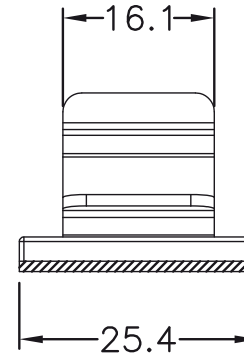

NOTE:
1. The height is not including the thickness of release paper

REV.	DESCRIPTION	DATE	TITLE: Cable holder self adhesive	DWG UNIT: MM
	MATERIAL: PA 66 (UL) 94 V-2		Modelled in RHINO 4.0	FILE: 11/12/14
	COLOUR: GREY		TOLLERANCES UNLESS NOTED	DwN:
			.XX= +/-010	ChkD:
			.XXX= +/-005	DT: 14.11.12.10632.E.0
			FRAC.= +/- 1/64	Part Number: 10632AA11AS
			ANG.= +/-1°	
			SHEET: 1 OF 1	
			SCALE: NTS	

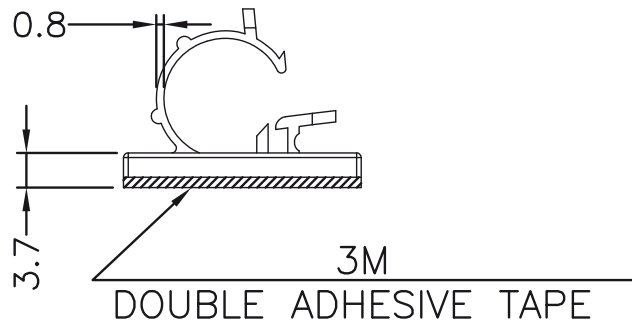
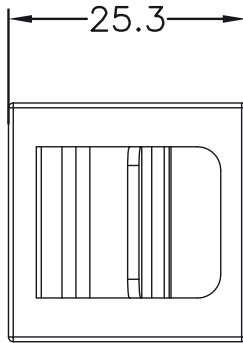